

HOMETOWN

**PLUSH
LIVING
ANYWHERE
IN THE
SOLAR
SYSTEM**

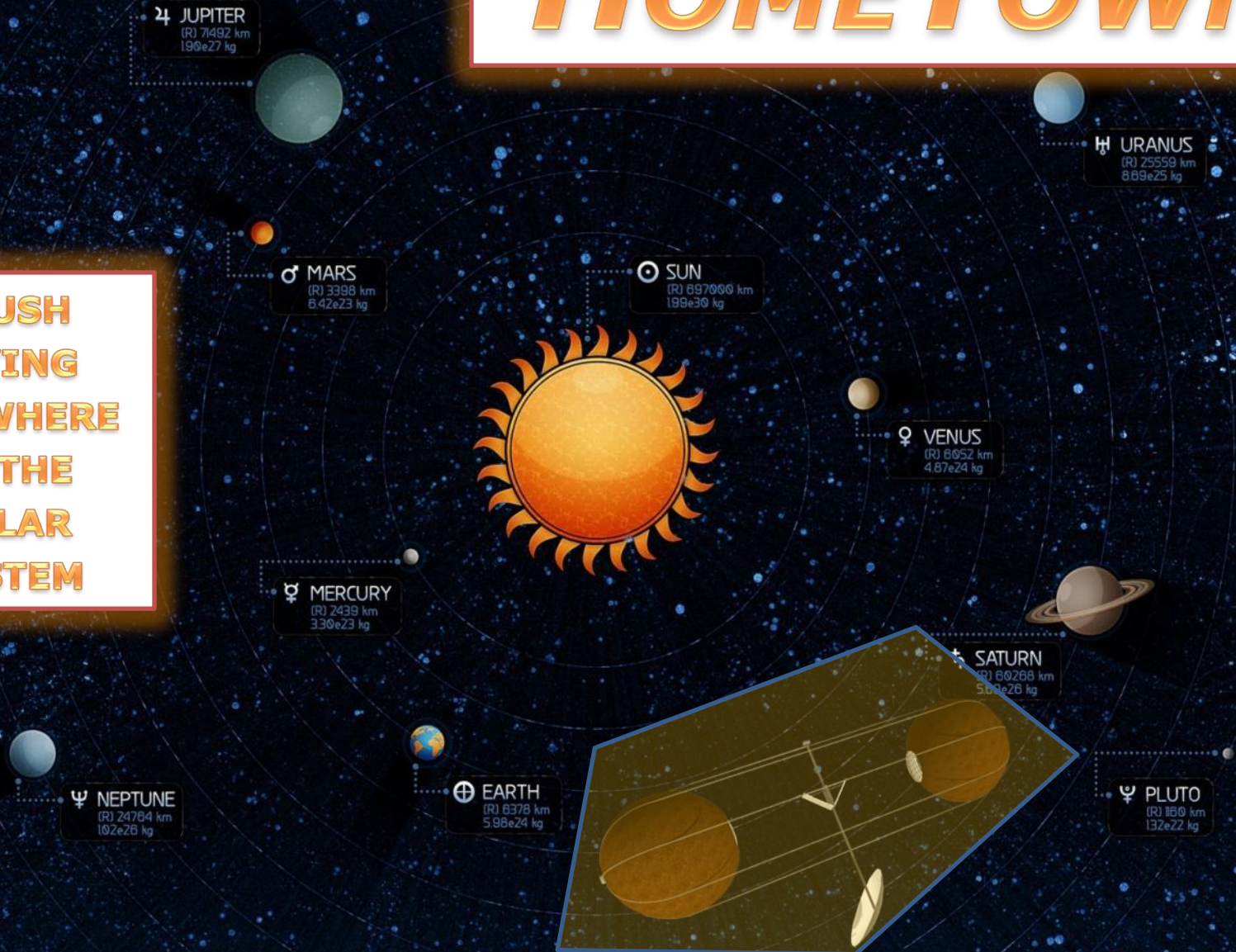

Not just for the frightfully fit and politically correct, life in HomeTown is to be a commercial venture. The concept has been developed as world building for a novel set 40-50 years in the future.

This worldbuilding "universe" is declared to be open for other writers to use if they wish, but please acknowledge and credit as appropriate and kind. Commercial use of images (other than a very few used in a writer's worldbuilding) would not be considered fair, frex. Concepts are considered fair use, as always. You write your novel(s) with HomeTown as a setting, and I'll write mine. I will be pleased and proud should you choose to do so.



(Hab image is not to scale in the preceding cover page, of course.)

INCOMING!

This looks like that Solar System which is infested by Terrans, as seen from the orbit of Jupiter

Actually, it is an artist's concept of recently discovered, carbon-rich Beta Pictoris system (Credit: NASA/FUSE/Lynette Cook)

But the idea is that no planet is all that safe from its neighbors

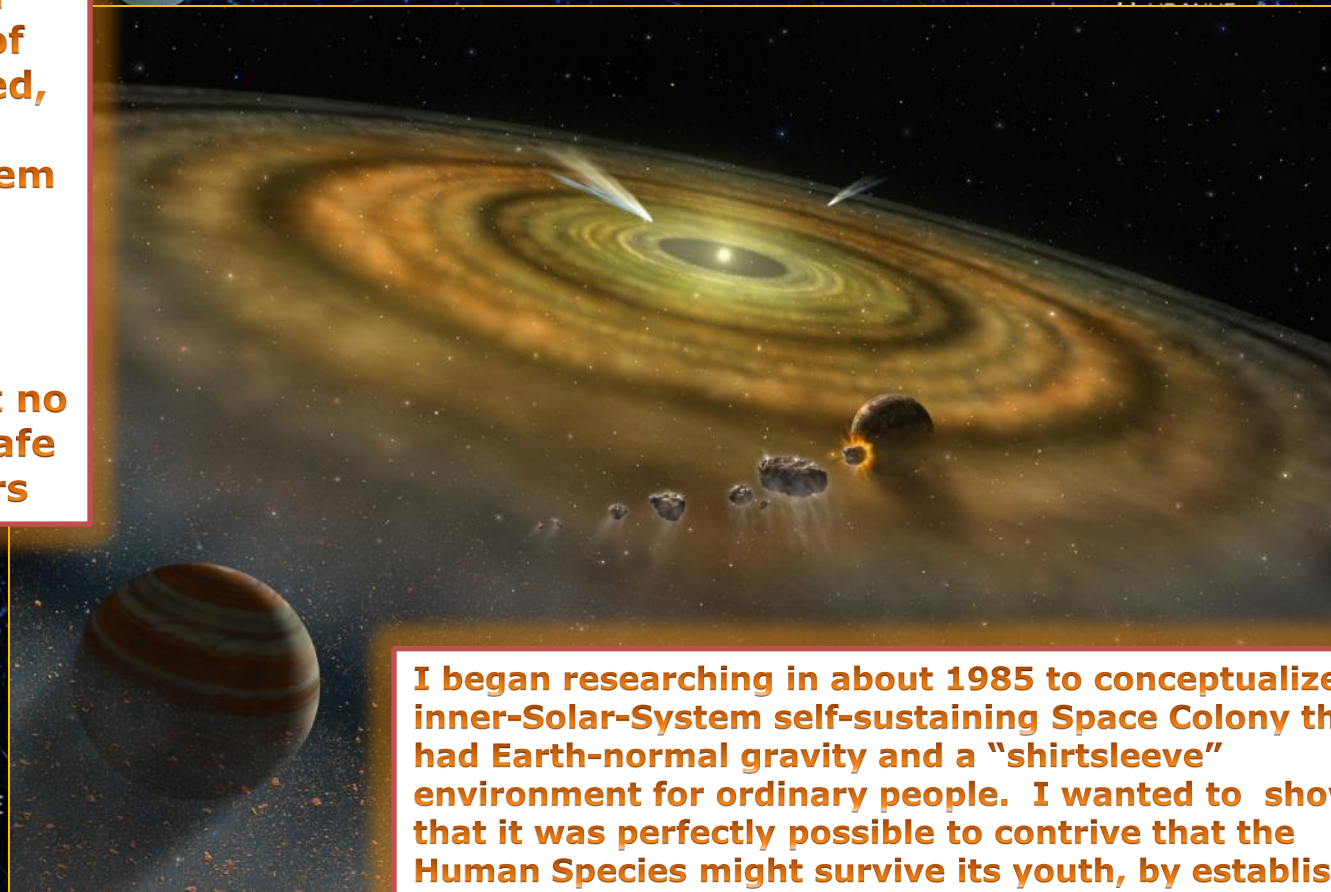

I began researching in about 1985 to conceptualize an inner-Solar-System self-sustaining Space Colony that had Earth-normal gravity and a "shirtsleeve" environment for ordinary people. I wanted to show that it was perfectly possible to contrive that the Human Species might survive its youth, by establishing backup populations elsewhere than only on Terra.

♃ NEPTUNE
(R) 24784 km
10.2e26 kg

Gerry Nordley calculated the masses involved to assure me that this was practical

The choice was between using carbon nanotube cables (derived from buckeyballs) as opposed to a smaller pair of asteroids tethered by stainless steel cables derived from ore from M-type asteroids; i.e., the innards scooped out of these ones. That was my original scheme, the idea being to use "off-the-shelf" capability of the very near future – if we just had cheap space access, such hubs could be turnkey-ready mere decades from now. But material scientists are confident that nanotube technology will be useable RSN (Real Soon Now), and with it there will be no worries about tensile strength.

Gerald Nordley pointed out that large hollow cables were much safer in the event of meteor strikes; even if a cable were holed in one or more places, the rest would retain integrity. He has done some of the studies for Tethers Unlimited -- <http://www.tethers.com/>.

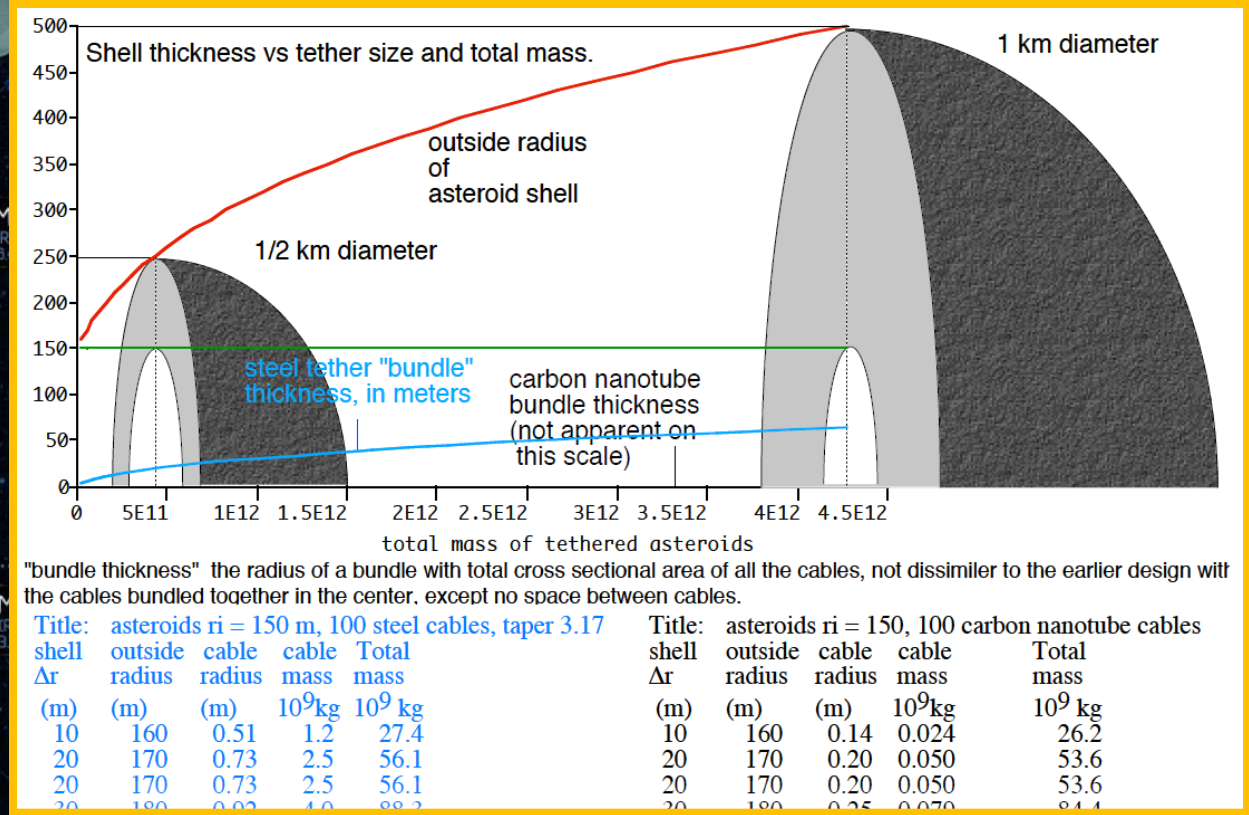

"bundle thickness" the radius of a bundle with total cross sectional area of all the cables, not dissimilar to the earlier design with the cables bundled together in the center, except no space between cables.

Title: asteroids $r_i = 150$ m, 100 steel cables, taper 3.17

shell Δr	outside radius (m)	cable radius (m)	cable mass (10^9 kg)	Total mass (10^9 kg)
10	160	0.51	1.2	27.4
20	170	0.73	2.5	56.1
20	170	0.73	2.5	56.1
20	180	0.93	4.0	98.2

Title: asteroids $r_i = 150$ m, 100 carbon nanotube cables

shell Δr	outside radius (m)	cable radius (m)	cable mass (10^9 kg)	Total mass (10^9 kg)
10	160	0.14	0.024	26.2
20	170	0.20	0.050	53.6
20	170	0.20	0.050	53.6
20	180	0.25	0.070	84.4

EARTH
(R) 6378 km
5.98e24 kg

PLUTO
(R) 1188 km
1.32e22 kg

Gravity by Tether Twirl

version 3.1 15 July 2010

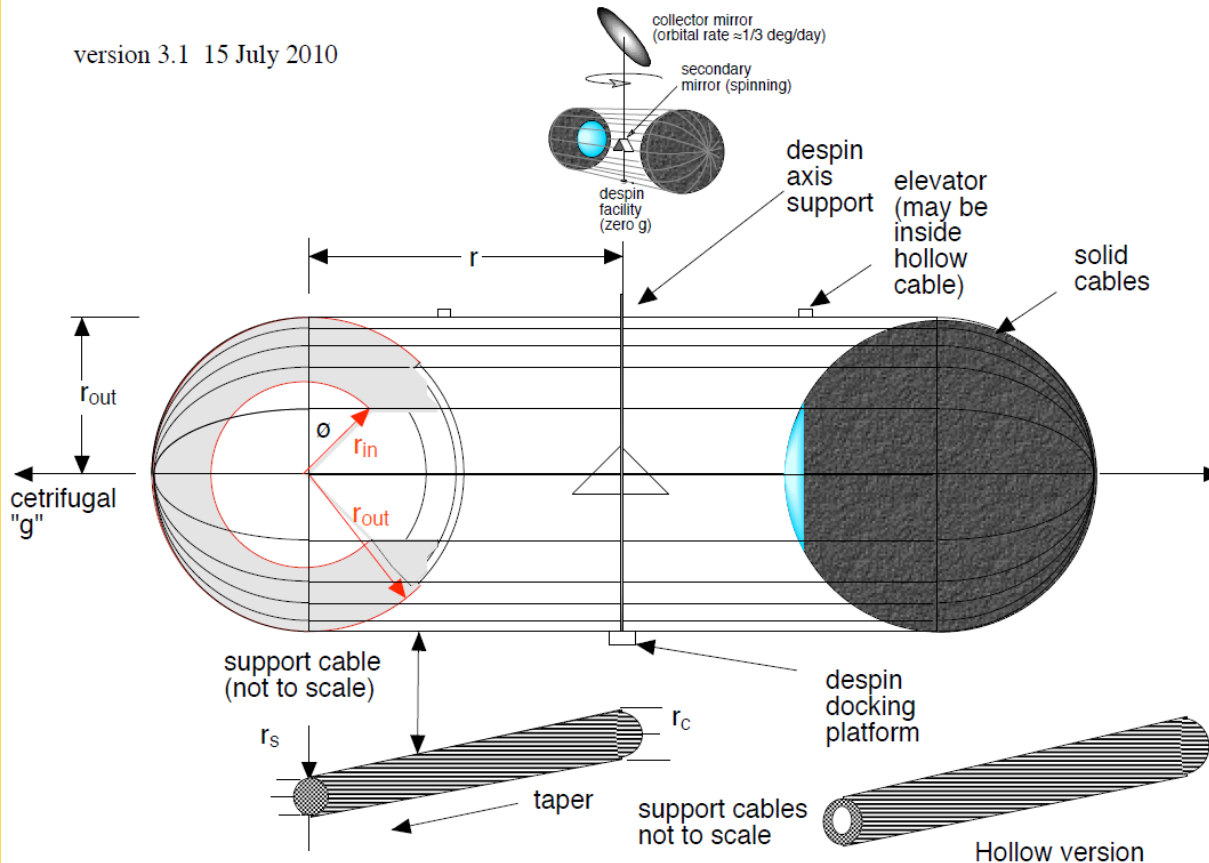

G. David Nordley originally intended to be an astronomer and majored in physics at **Macalester College, in St. Paul, MN** with that in mind. But, faced with the reality of the draft after graduation, he joined the **US Air Force** as an airman basic in 1969. He spent some time in radar intercept control and battle management, including tours in Alaska and Korea, but worked mainly as an **astronautical engineer, managing satellite operations, engineering, and advanced propulsion research.**

In the latter capacity, Gerry met and became inspired to write by physicist and author **Dr. Robert L. Forward**. He retired as a major at the end of 1989 and began submitting stories in 1990, using the "G. David" form of his name for fiction (though lately it has migrated to articles as well) and **Gerald D.** for technical papers, the intent being to separate the work in computer author searches.

Render of 3D CAD/CAM Technical Design

Ships can dock on the outer waistline of the asteroids or at the de-spinner at center bottom.

The mirror captures sunlight and reflects it, 24/7, into the domes capping the asteroids, each dome appearing to be overhead for the inhabitants.

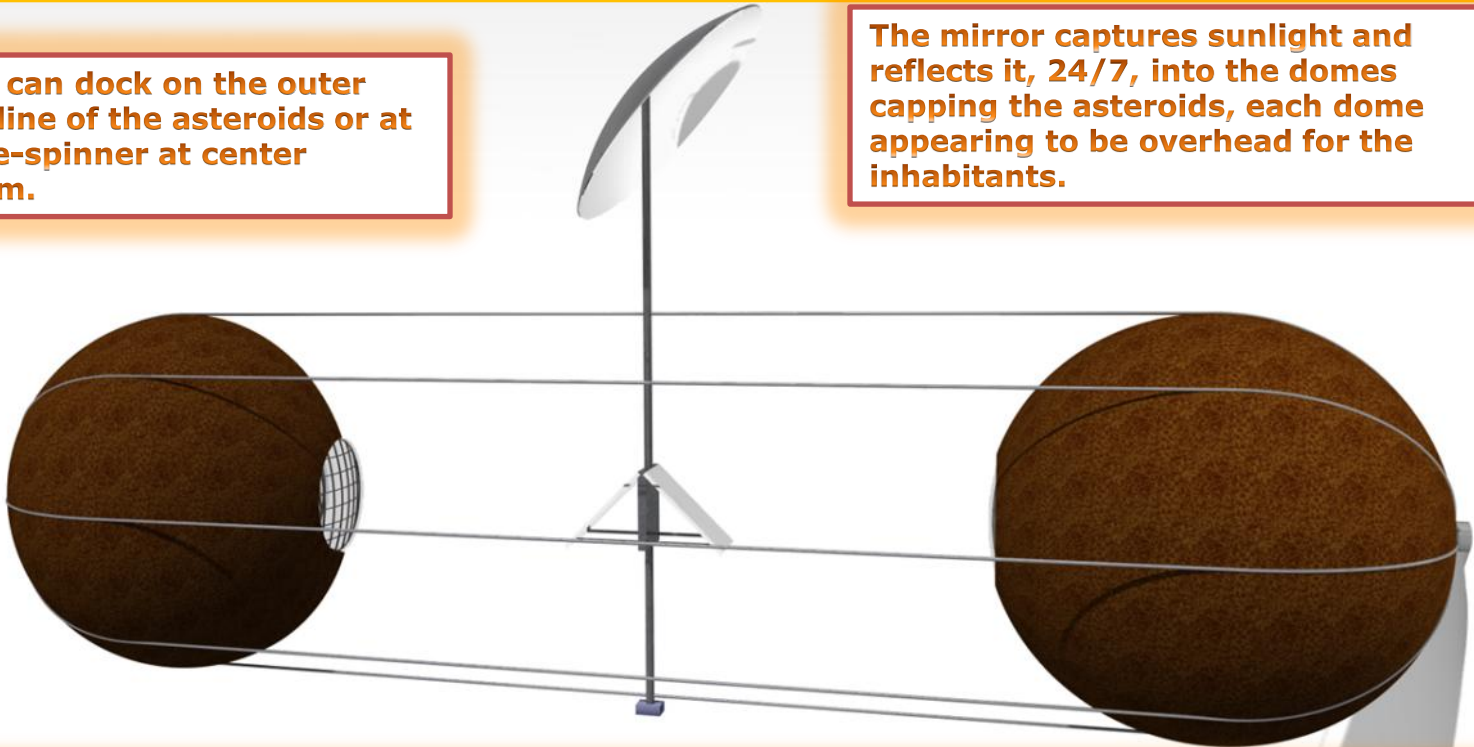

Brady Thomes, Technical Designer – see <http://the-brade.deviantart.com/gallery/#3D> -- I am particularly keen to make certain that Brady receives credit for any use of his work. In order to be certain that the dimensions and human proportions were actually valid in my worldbuilding of HomeTown, I tried building it in CatiaV, a 3D CAD/CAM system, as a student project. I soon saw that I was unlikely to develop enough skill to “do it right” so I enlisted Brady, an expert. This worldbuilding effort is an open universe for other writers, but please acknowledge and credit us.

The idea is that were I to write that my protag sprinted off in this or that direction, and somebody with better math worked it out, I would get helpful emails to the effect of, “Do you really mean to have him walking on water, or is this an oops?” But when everything is built up from scratch, with exact dimensions generated by the CAD/CAM, including the human figurines, well, WYSIWYG -- really.

Cables are hollow and used to travel back and forth, and also to run pipelines.

If there is undue heat buildup within the habs, water from the Home Sea can be piped along the cable walls and re-circulated as coolant

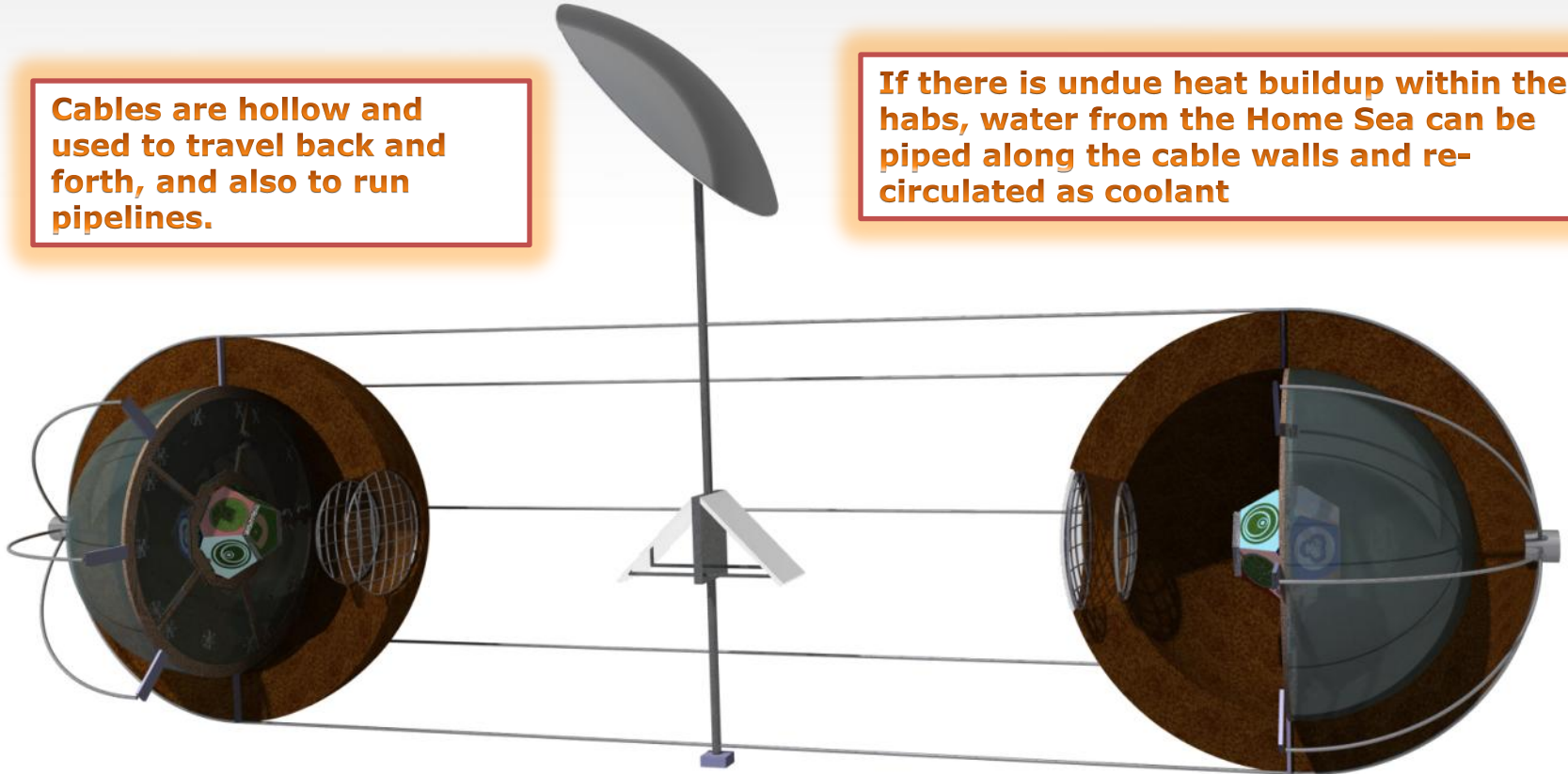

LR/ 2439 km
330e23 kg

These asteroids are M-type (mostly metal) and have been moved by mass drivers within Near-Earth Orbit to position them to service other expeditions within the Solar System. As each asteroid travels, the prospector robot crafts fetch useful volatiles from smaller asteroids and extinct comets, and the basic units are injection molded and assembled into their honeycomb structures in near-zero-gee by self-replicating robots. Upon arrival, two (or more) asteroids are cabled together, centrifugal spin is applied using computer controlled steam-nuclear engines – the water in each asteroid goes “down”, the air goes “up” and the hab floats in the middle.

The mirror assembly at center-point between the spinning asteroids captures sunlight and reflects it, 24/7, into the domes capping each one; the domes would appear to be overhead to the inhabitants.

The shadow positions in this 3D CAD/CAM rendering are cockeyed because only half the shell is present (just in case somebody notices).

Within the remaining shell, tunnels lead to five small nuclear-steam plants, to generate electricity and use steam-exhaust rocket propulsion to move the asteroids into position and achieve and maintain their twirl. Highly redundant computing capacity keeps it all in sync.

The robots doing nearly all the mining, refining, building and assembling are self-replicating using asteroid materials, loosely supervised by teleoperators elsewhere in the Solar System. <http://telerobotics.stanford.edu/publications/index.html> is a start on background for this.

Judy R. Johnson, Ideas (JJ Perry, pen name)

Brady Thomes, Tech Designer

Gerald D. Nordley, Scientific Advisor

Cutaway view, looking up (or down) through one dome toward the other hab asteroid, with the light reflector between them.

Are you dizzy yet?

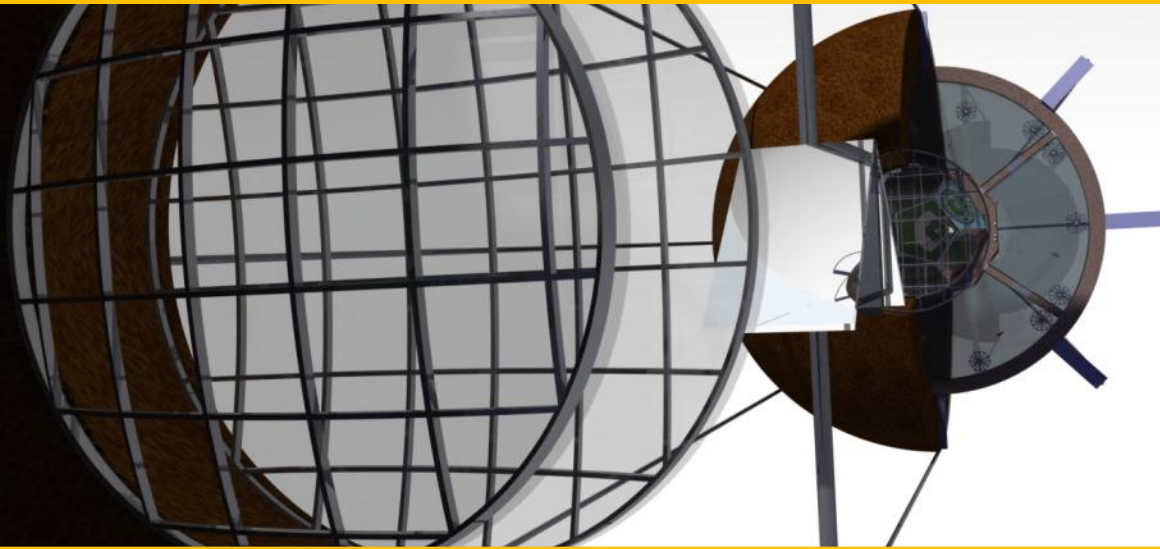

You can see in this cutaway view the tunnels coming from the docking stations set around the waist of each asteroid, connected to the hollow cable tethers. The cables offer roads and pipelines between habs.

Cable races could be a sport, enabling all sorts of stats because of the variations in gravity along their length.

The outermost ring boulevard is fixed to the asteroid wall. The spokes and hub float and adjust to water level

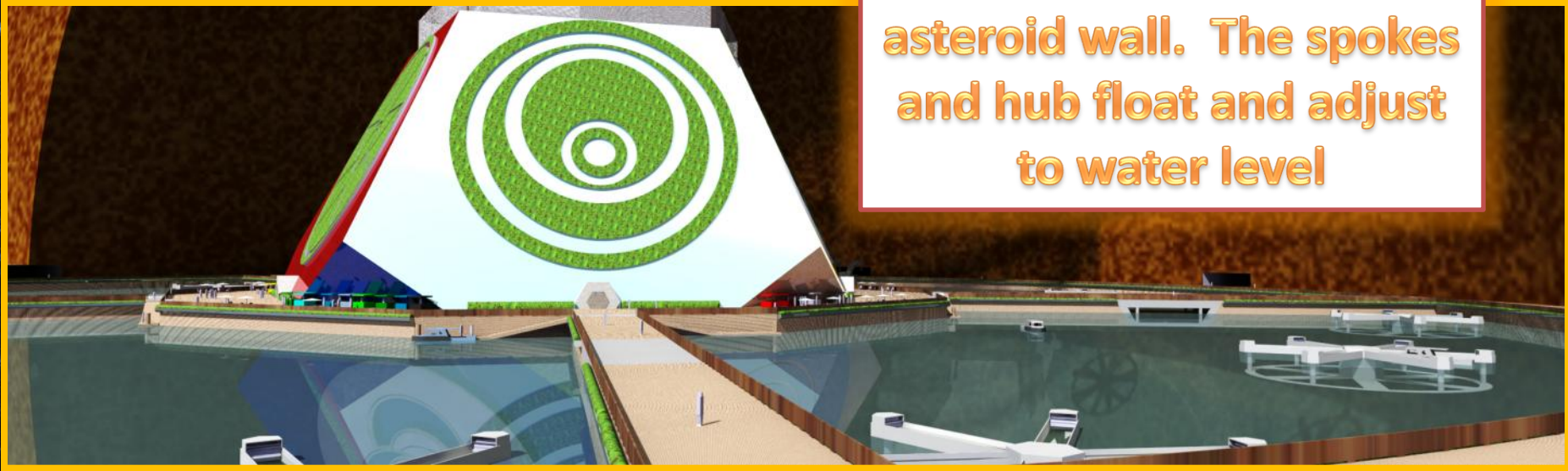

Hometown makes its living by hauling water ice from out-gassed comets found in Near-Earth orbit and as far away as the Asteroid Belt, a steady procession of frozen mudballs headed its way, to be melted and processed in zero-gee space both in transit and near the hab. The water, oxygen, hydrogen, ore, trace elements and other goodies extracted from it – all are for sale to other space enterprises and expeditions, with very little depending on trade with Terra. The floating algae-growing wheels are part of this, for food, drugs, and chemicals. This place is alive!

Also for sale are housing, rest and recreation, repair facilities, resupply of life support and equipment, and medical facilities. In particular, HomeTown offers an Earth-normal gravity for human gestation, birth, rearing, and education of children. Other nearby habs may offer lower gravity for geriatric facilities. Those are CAD/CAM generated human figures on the bridge, automatically to scale.

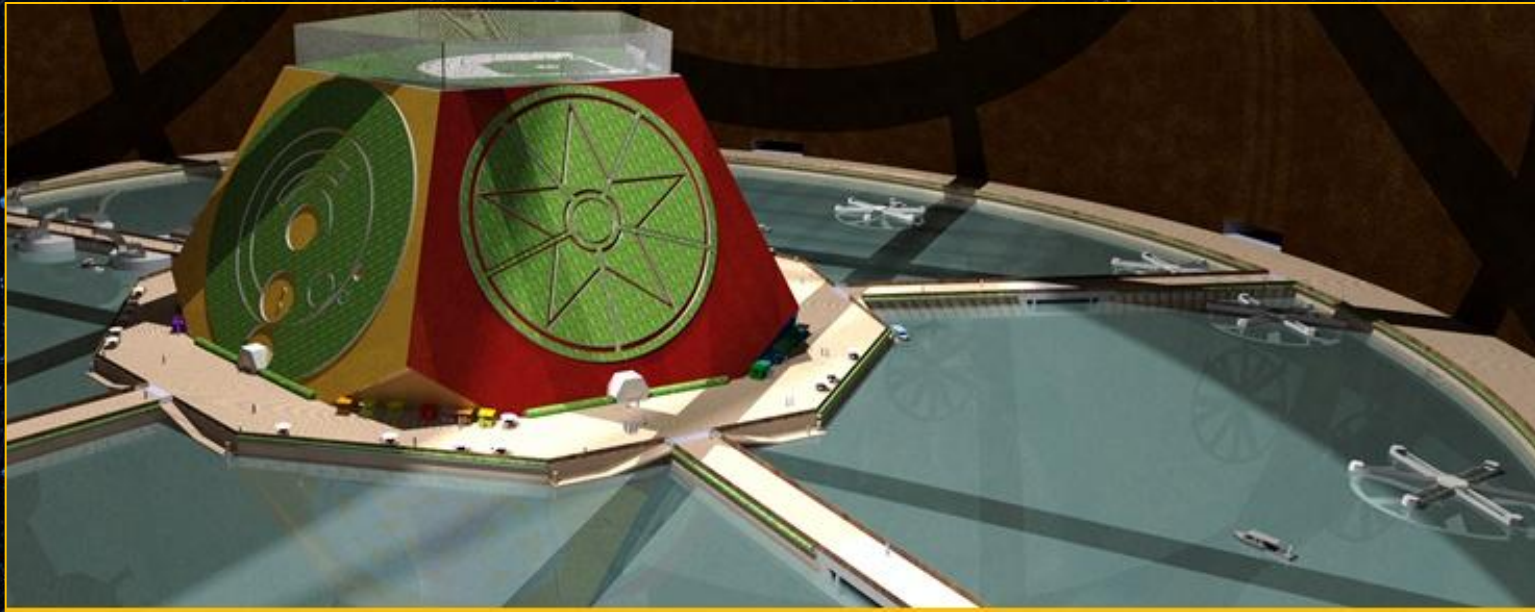

Underneath the rings and spokes are the chemical and biochemical vats and pipelines. Some manufacturing is done there, more inside the central hab, but generally not physically large, dirty or dangerous endeavors – those are better done in facilities out in nearby space, anyway. Small parts can be supplied by photolithographic processes – that’s 3D fax – with data beamed from Terra whenever necessary.

Since the sunlight is controllable by positioning the central mirrors between the habs, it can be varied to suit, but here “outdoors” it will be some flavor of daylight 24/7. Inside the hab, time will vary for each of the 12 sections – two hours difference, and every mecon has a wall panel that tracks all this and much more. So there is never a time when “outdoors” is underutilized, and all the small businesses keep their own local schedule, and there is always a pharmacy open somewhere in town, always breakfast when your own timing wants it. The street vendors with their pushcarts come and go on the boardwalks.

What shall we name the Hometown baseball team?

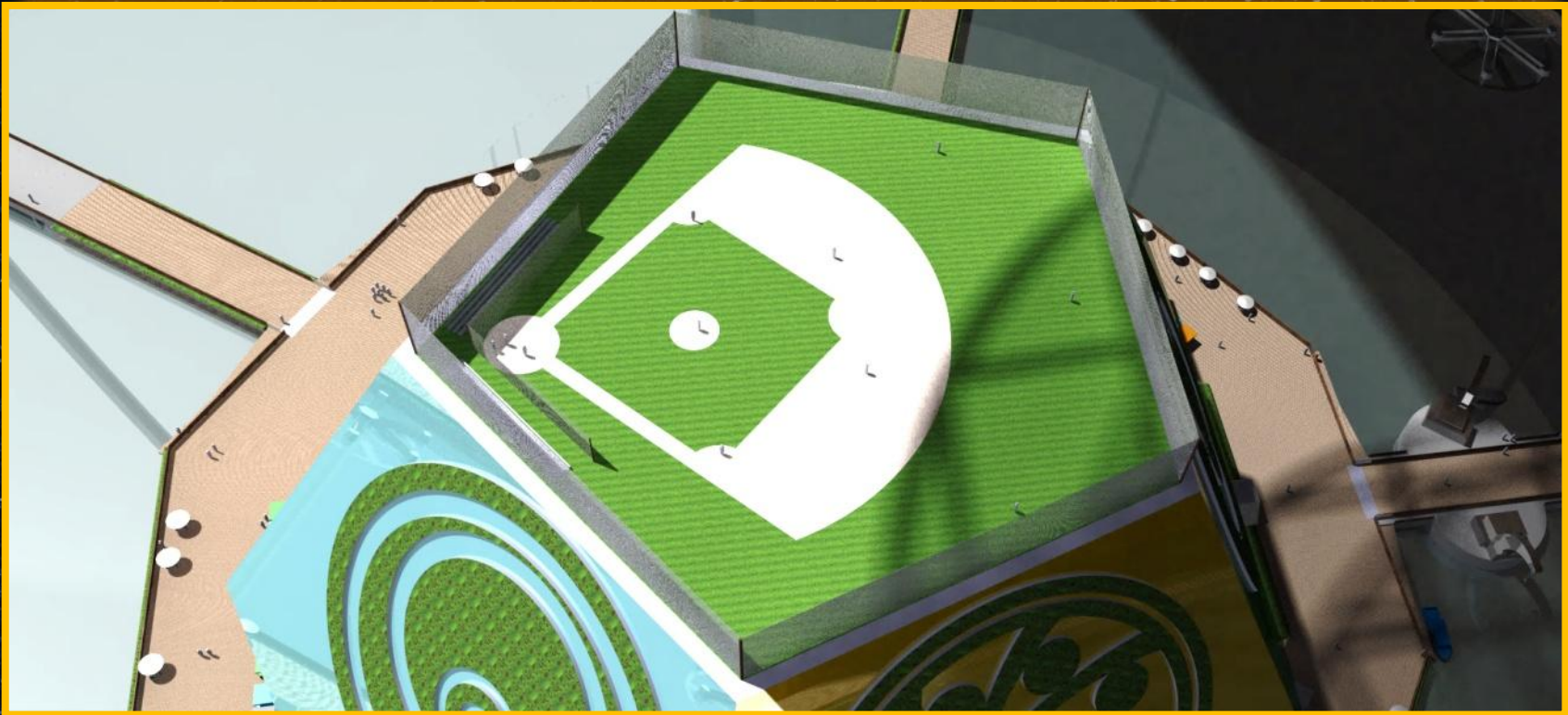

Homers batted over the fence may be fielded by belugas! We might make a ball return setup, too: they spit the ball into a net at dockside, see, and then the ball is transported by vacuum tube back up to the diamond. Smallish bleachers and dugouts are behind the home plate, but 3D TV projected onto the interior walls of the cavern would make viewing games from the Boardwalk preferable to bleachers. If we had been able to come up with a CAD/CAM program actually on this laptop, we could twirl and zoom the 3D images to see the baseball field anyway we like.

The boardwalk below accommodates café society, fishing, walks, whatever, with a climate somewhere between seaside and large lakeside beaches. Serious runners and joggers would use the tracks next to the asteroid wall.

Café society and street vendors on the boulevards

♃ JUPITER
(R) 71492 km
190e27 kg

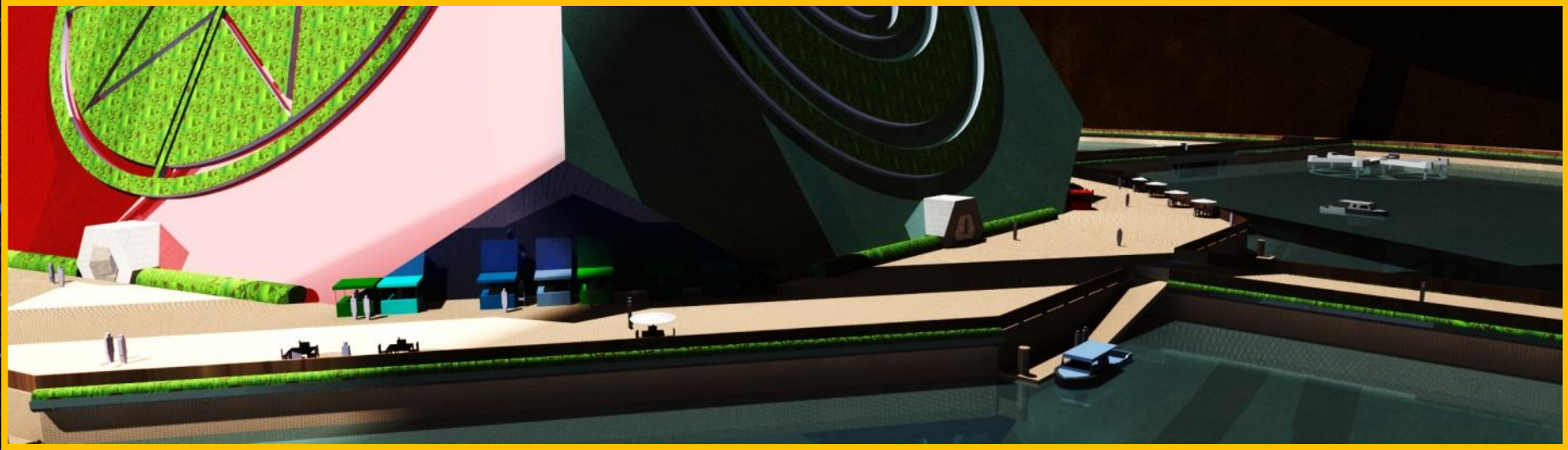

♿ MERCURY
(R) 2439 km

The HomeSea is managed as a small lake with pretensions of being a tiny ocean, tweaked as necessary to keep it as close to ecological balance as the resident team of scientists can make it.

The apex predators are beluga whales with enhanced communicators; they are voting citizens, consenting scientific subjects, and participants in scientific and philosophical advancement. The bottom sections of the hab feature underwater views of reefs and venues for restaurants, etc. – aquarium denizens looking back.

This is a mecon – a truncated octahedron – the basic unit of HomeTown's honeycomb construction

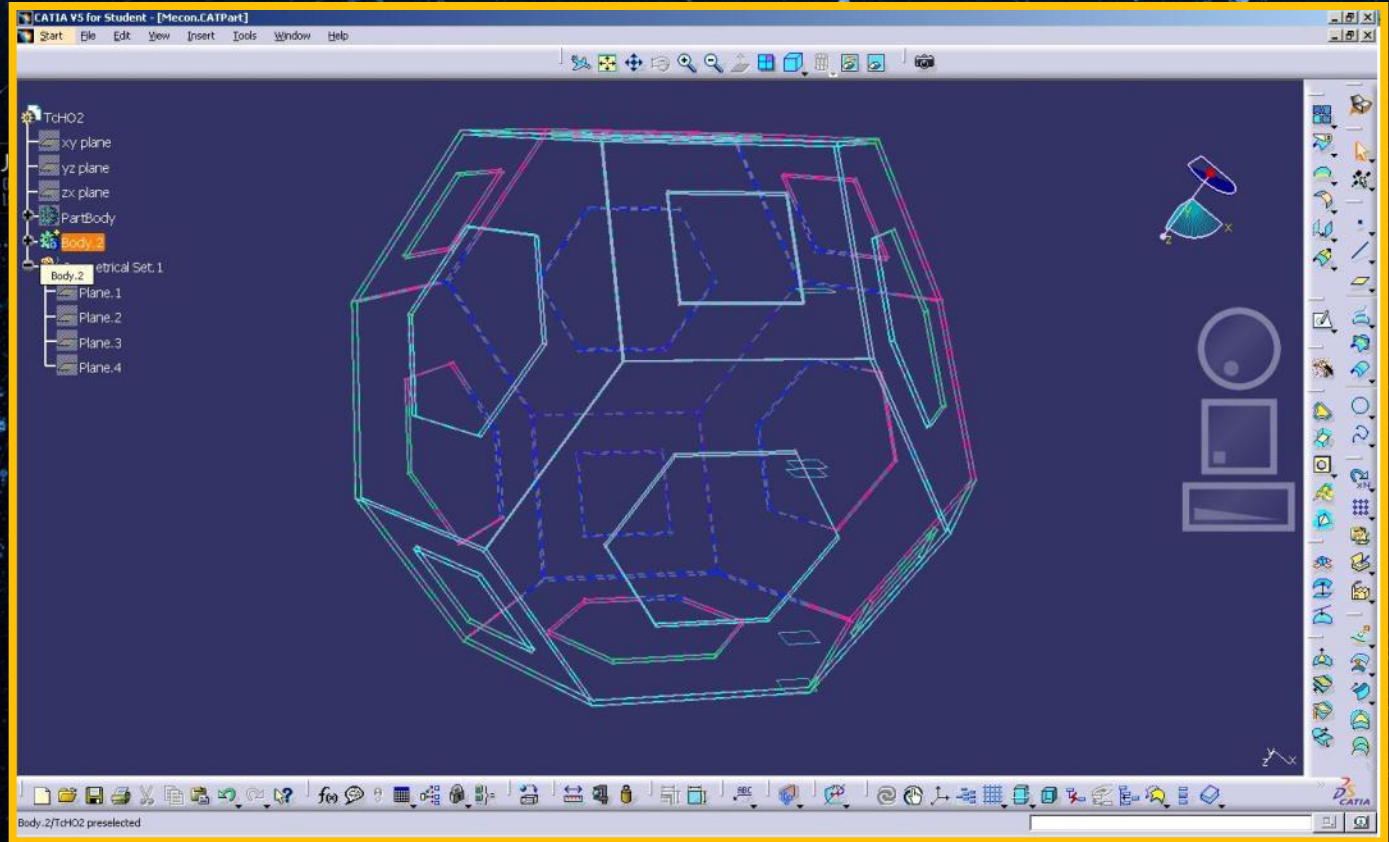

There are six square sides and eight hexagonal sides, and it will “pack” with mathematical exactitude -- no extra spaces between any of the facets. Here you see a screenshot from the CatiaV 3D CAD/CAM program. Below, “A Fuller Explanation” seems to be a Buckminster Fuller pun but the science is valid.

**Amy C. Edmondson A Fuller Explanation
Chapter 12, "All-Space" Filling: New Types of Packing Crates
pages 184 through 188 -- Truncated Octahedron**

The hab is a dodecahedron shape, with 12 sections and a hollow atrium in the center

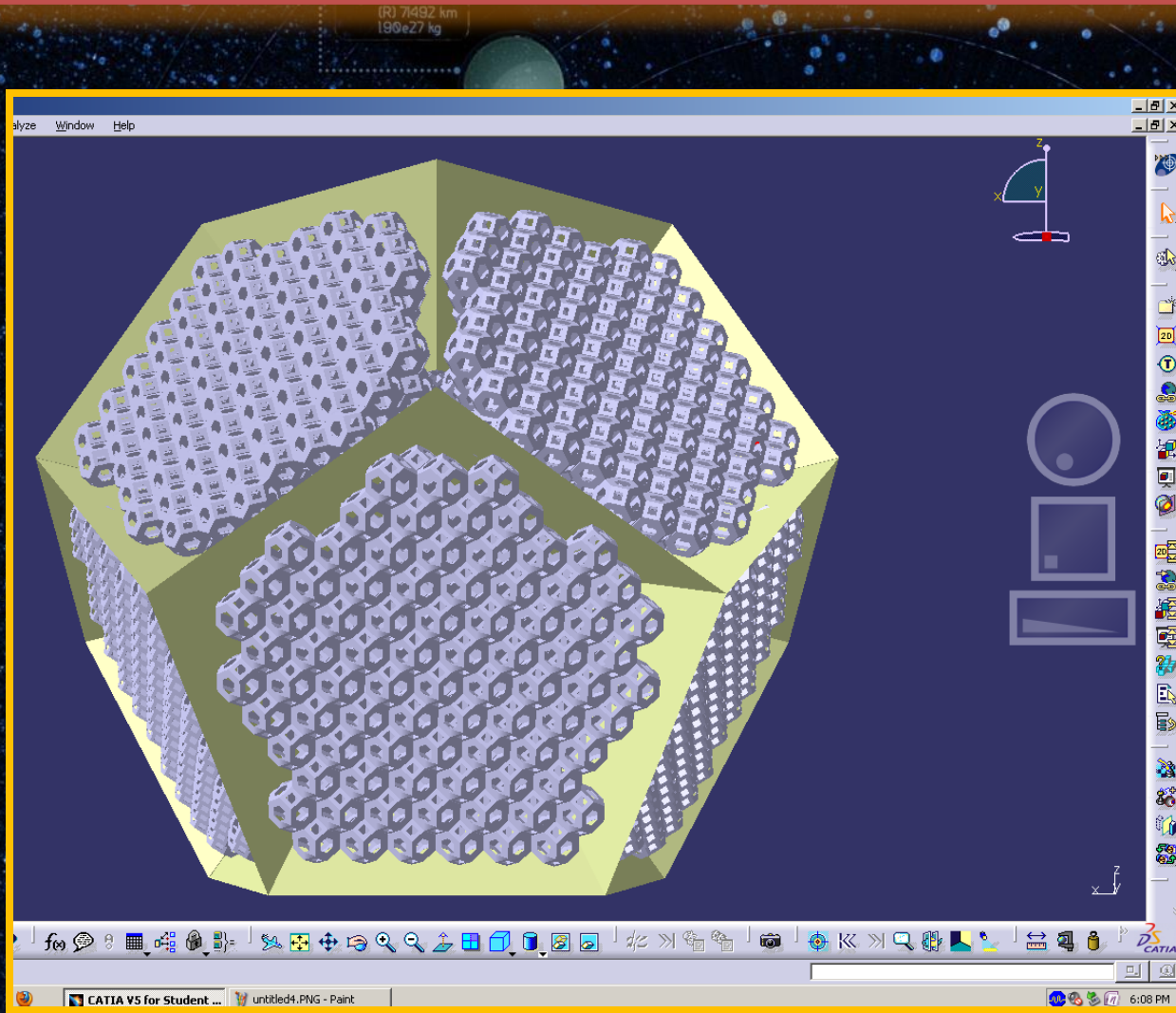

About 100 mecons per section, twelve sections, perhaps one person per mecon, and we're talking a population of a small town. Some units will have more people, some less – this is an estimate. But I've lived in small towns; I understand their dynamics.

Because the design is done in CAD/CAM, the dimensions are not guesswork. You start with 12-gauge stainless steel, exact measurement of one hex, ditto square, and put them together in CAD/CAM to make a mecon – controlled so it CANNOT overlap or gap – the program won't let you. Then you duplicate to make a section, then replicate the sections, color them, and add perfectly proportional human figures generated by the CAD/CAM.

CAD/CAM screenshots showing different orientations of a Mecon

Each unit is injection-molded from ore smelted inside the asteroid being hollowed as it is traveling to its new location, and the sections packed together and assembled in zero-gee. Because they “pack” no other structure-building is necessary – no girders or beams – anymore than there would be in throwing a diamond hitch on a mule. If nothing better offered, homemade stainless steel chains and chain binders would ensure integrity for each section, and the sections could be held together the same way.

Only after all the heavy lifting is done will spin be put on the tethered duo asteroids, and pseudo-gravity commence. (I did these CAD/CAM constructions myself.)

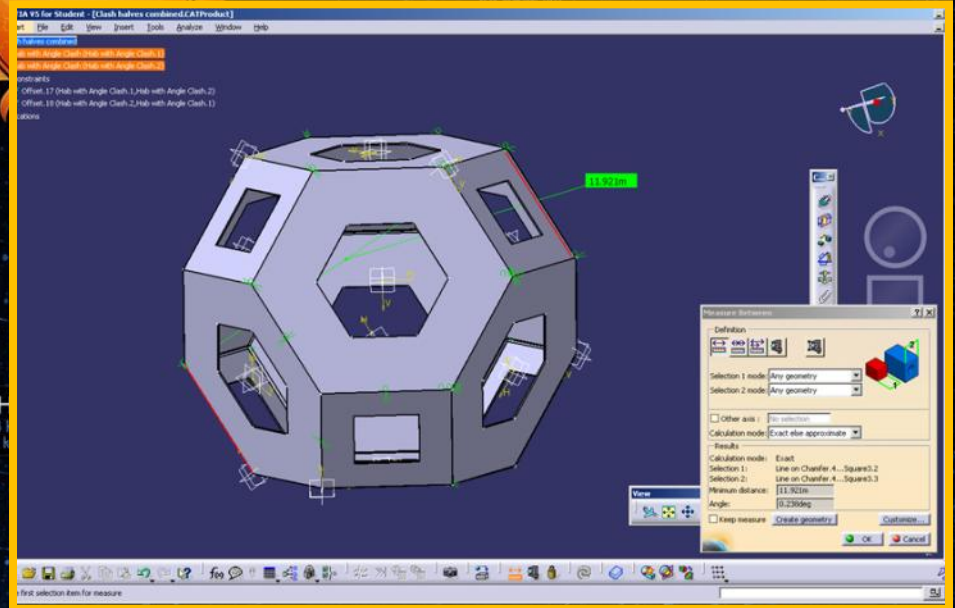
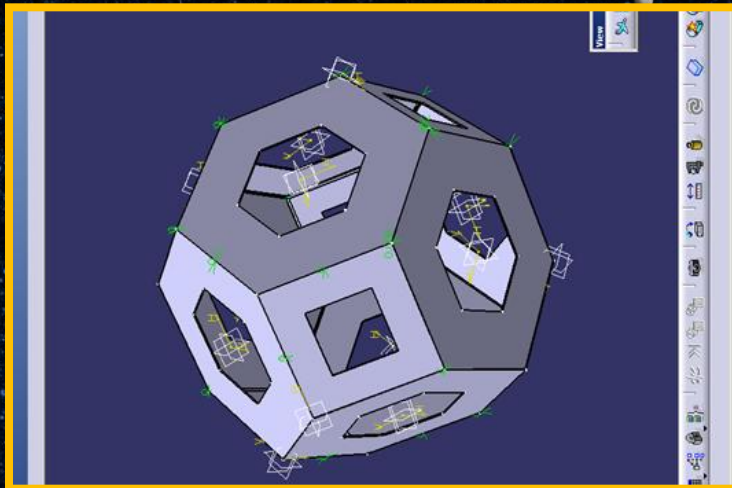
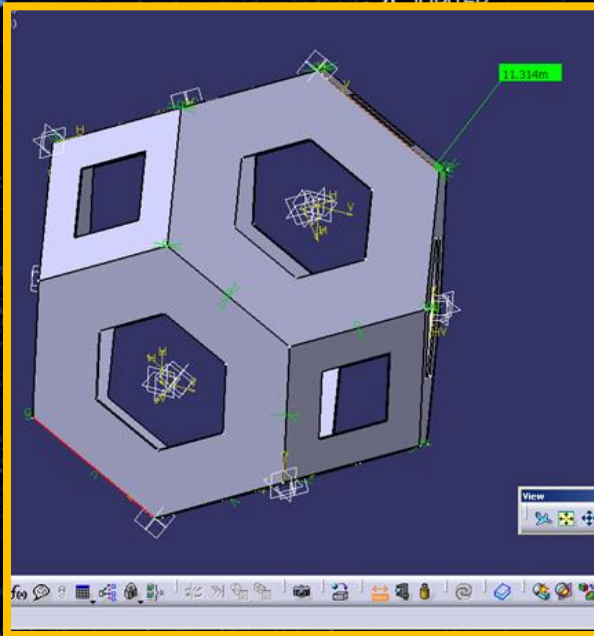

Cutaway view to show mecons clamped together by bolting hatches to each other

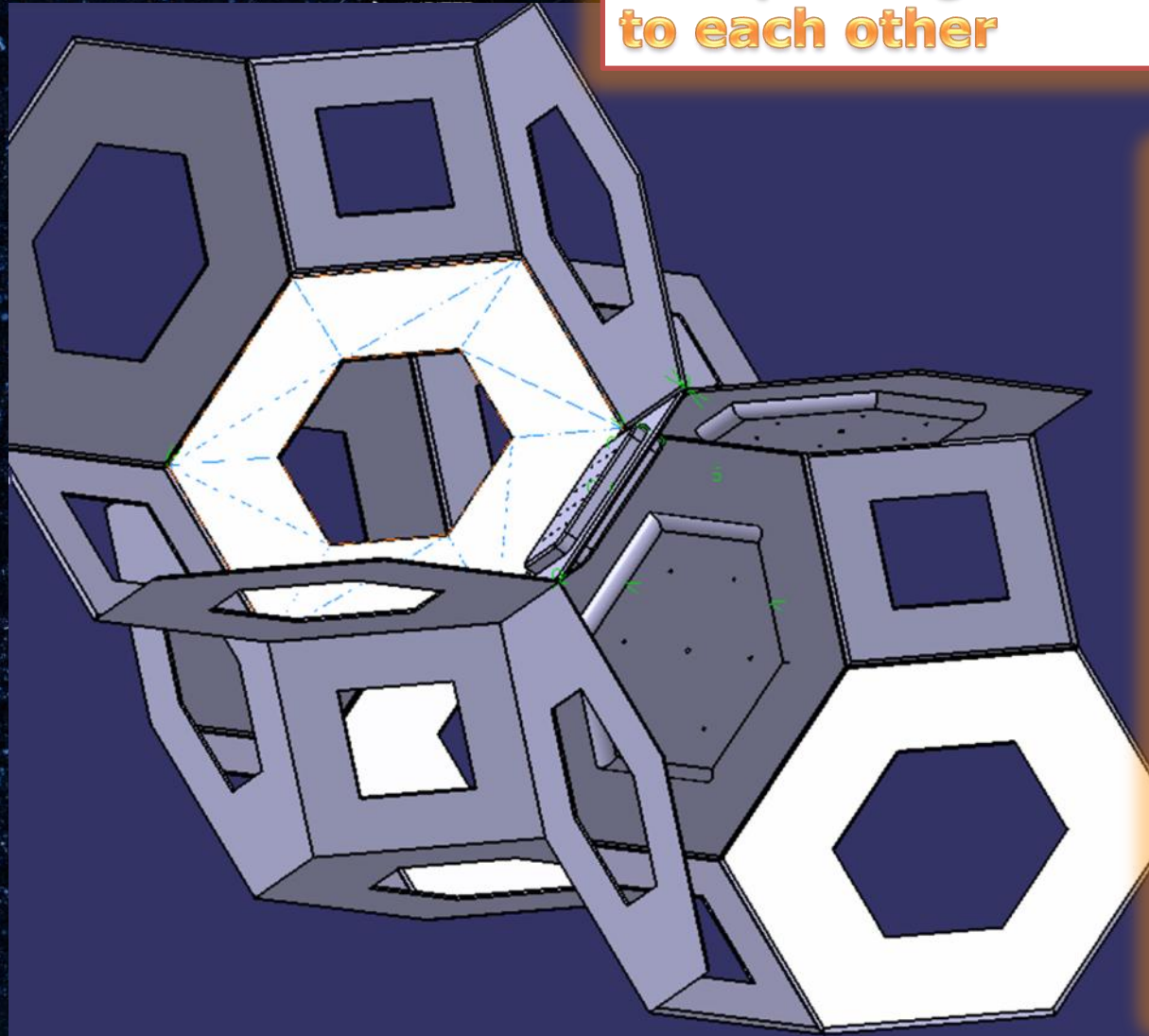

The openings in each facet can be left open or closed – two hex facets already mated within the packing will have hatches on each interior side, bolted to each other, and this, along with the honeycomb packing, is what holds the entire section together. No welding, no trusses, no girders – just honeycomb. Bees do it, why can't we?

The hatch bolts will be eyebolts, so there are attachment points from which all else inside the mecons depend. Again, no welding necessary. Most facet openings will be hatched semi-permanently and sealed; the actual doors are automatically shutting airlocks.

**Straight
from
CAD/CAM,
an
airlock/
door
between
mecons**

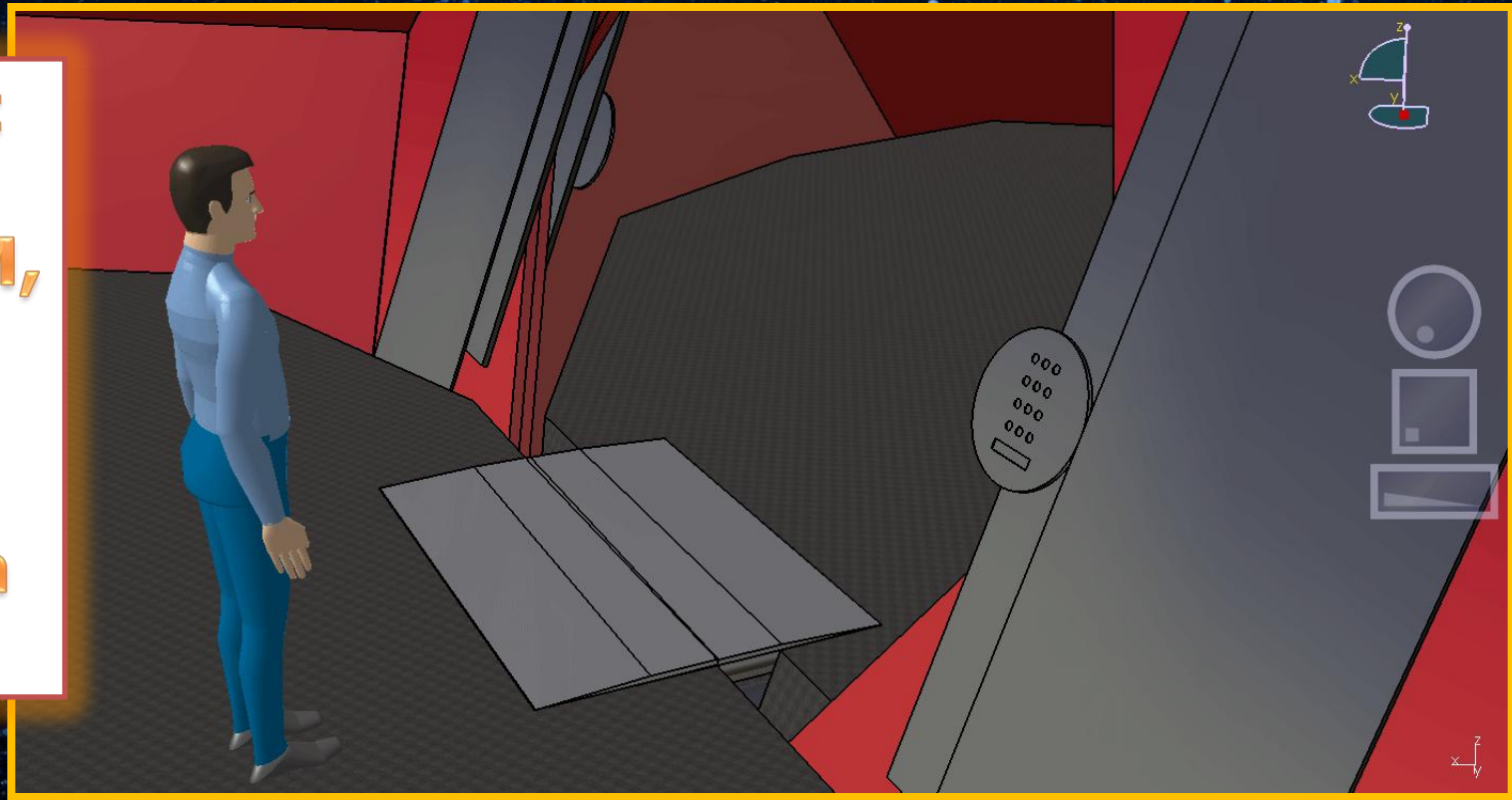

Animation, oh my! Switch to PPT Slide Show view to see the action, or go to [Brady's website](#) .

This door works as a "Dead Man Switch." Default for the airlock door mechanisms is shut; at least three computers constantly need to be telling the ensemble that it is OK to be open so that the pipes can be sealed together and transporting water, waste, atmosphere, and packages. Each mecon has emergency supplies if cut off by some temporary glitch or the Really Big Emergency, and people make dirty jokes about all the emergency drills they must do.

If necessary in case of collision/breakup, each of the 12 sections is designed to be self-supporting for months, and the methane digesters can produce fuel for steam propulsion for slow travel. People would be uncomfortable but if they survived the initial disaster they could be rescued.

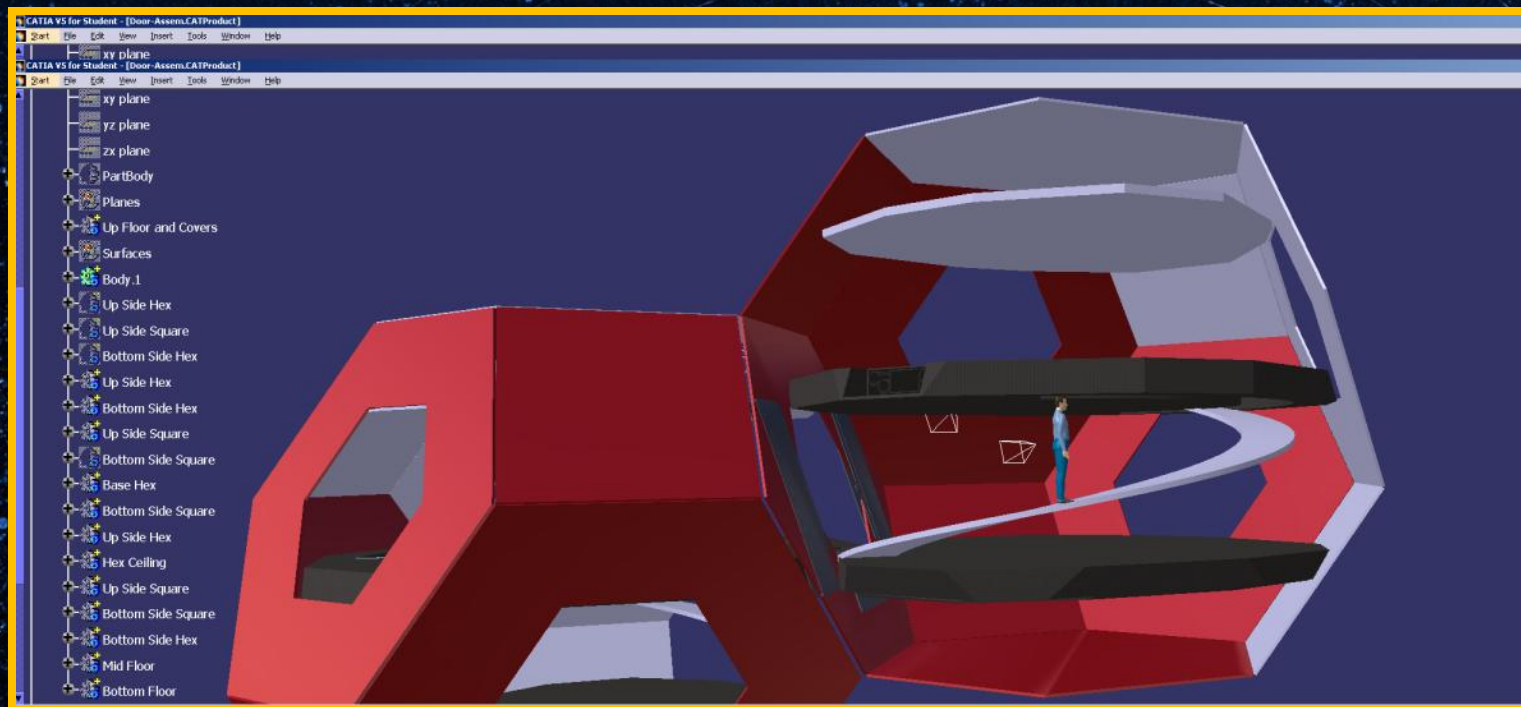

Early stage of Tech design of mecon pipes and delivery systems inside floors

The ecologists also oversee the agricultural production, which is not large fields but instead scattered throughout the whole complex, mostly in the attics and basements of the mecon living quarters, with a two-story apartment for living in between. Here, in this early stage of the tech design, I was reassured that the proportions would work; it actually is humanly livable, because the human figures are CAD/CAM generated – they CANNOT be out of synch.

Small robots travel through the square piping and thick floors to tend the crops without disturbing the people in the two center apartment floors. You can choose whether to leave openings at the edges of the floor so greenery can grow up from the basement or vines trail down from the attic. Or have it sealed; up to you.

Small neighborhood hub

24 JUPITER
(R) 71492 km
190e27 kg

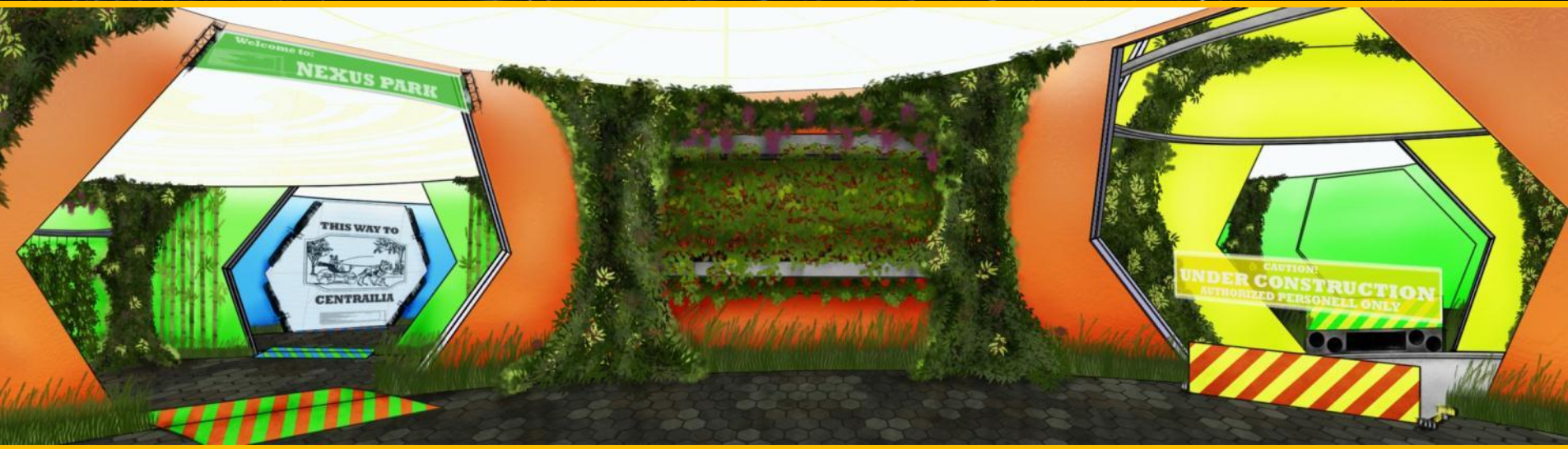

Here, the vines are espaliered but the planters with growth medium reside in the basement and attics, as shown in the right-hand mecon that is under construction. Notice the ceilings in the other two mecons; they are lighted with sunlight transported by fiber optic cables, the rays coming in through the domes, reflected off the mirror between the two asteroids. It's a passive system that will work even during power outages, so long as the mirrors are aligned to catch the sun.

The doorway cover plates are contrasting colors to warn people to get off them if the siren blows; the plates will pop open and the airlock doors close – you'd better not be in the way. There can be areas planted to grass, and gengineered goats to graze on them and browse on other plant clippings fetched by robots, and door netting as fences to keep human and goat kids respectful of each other. How about monkeys to harvest stuff?

This gives a sense of proportions and how the paths work out

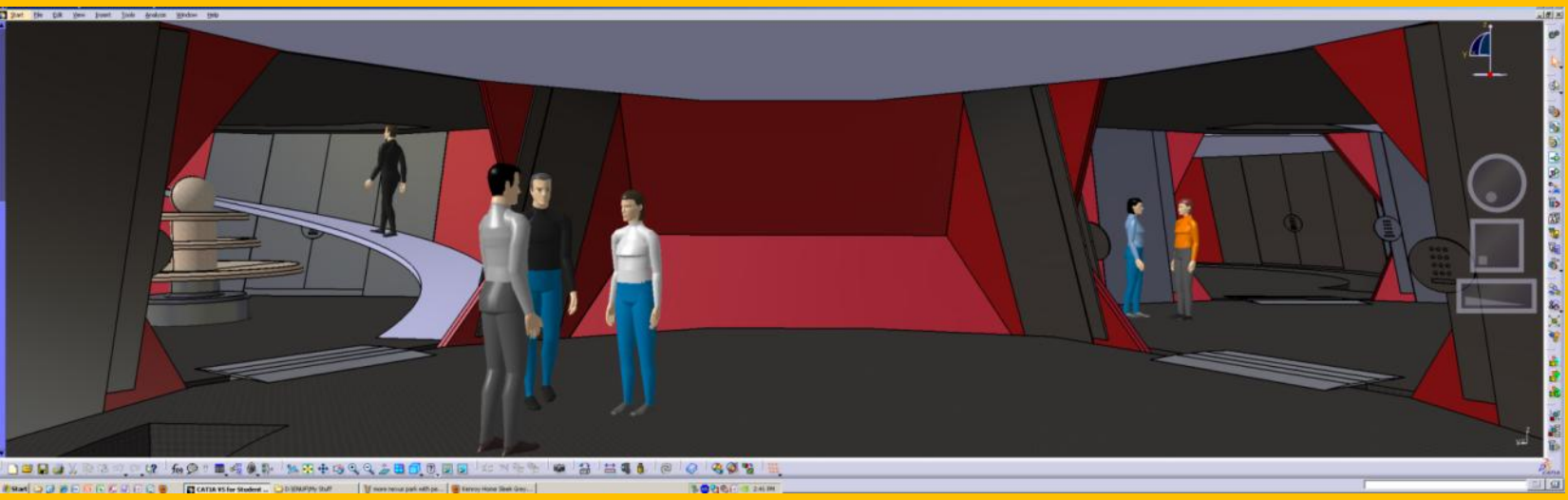
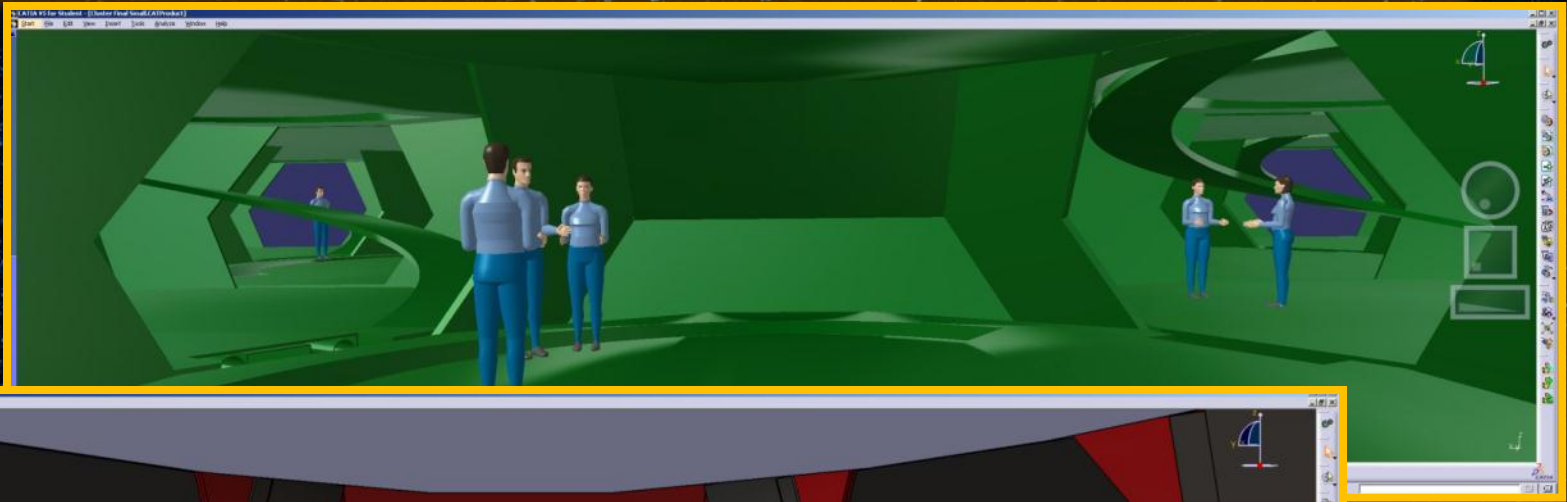

♆ NEPTUNE
(R) 24784 km
102e26 kg

♁ EARTH
(R) 6378 km
5.98e24 kg

♇ PLUTO
(R) 1188 km
132e22 kg

Notice the connections in the doorways. And the ability to have straight, although narrow, roadways. The ramps can be left out where a straight road is required.

Interior core between the sections

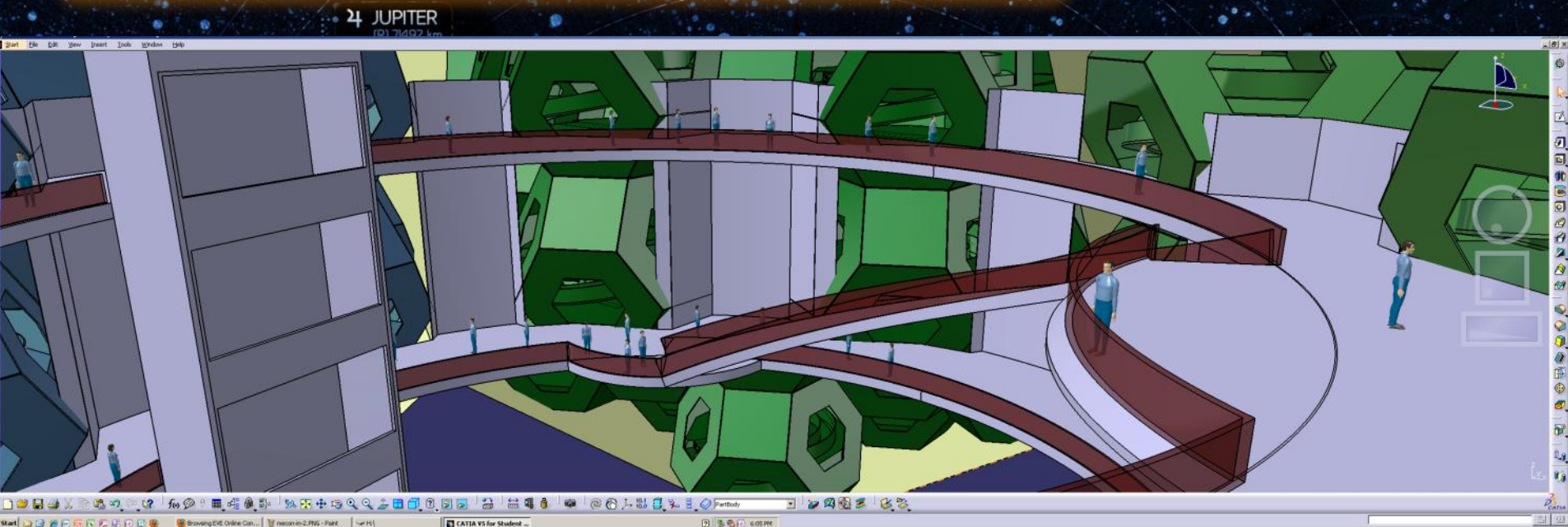

Brady and I are still deciding how to build this, but this preliminary visualization gives a sense of how the proportions and distances work, which is mainly what I need. Communications between the levels will mostly be by six helixes going up the atrium, enclosed in steel netting for safety, with low-incline ramps and then a few seats like ski-lifts along the side.

Most business is pushcarts taken back and forth from homes to the Boardwalk, and they can be clamped to a cog rail or some such more sophisticated system moving along the helix floor, with all the utilities piping along below the floors. Only a few elevators will be available.

When one can provide a laptop with the software installed on it, the CAD/CAM would allow the picture to be manipulated in 3D.

Home, Space home

♃ JUPITER
(R) 71492 km
190e27 kg



♆ NEPTUNE
(R) 24784 km
102e26 kg

♁ EARTH
(R) 6378 km
5.98e24 kg

♇ PLUTO
(R) 1188 km
132e22 kg

